

**Scaledrawings**

**1:50 & 1:87**

**J.F. van der Touw**

# BOOKS

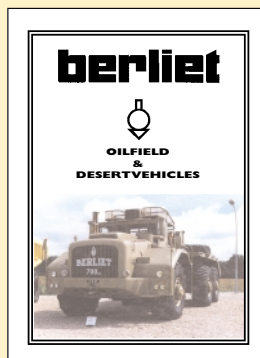
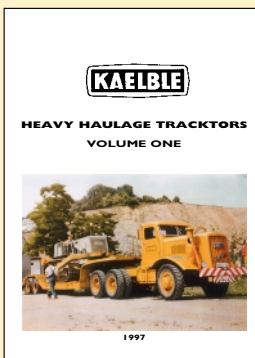
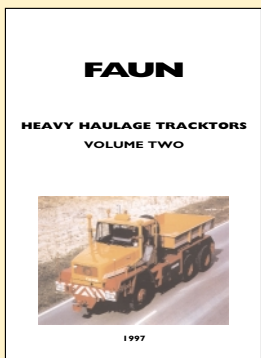
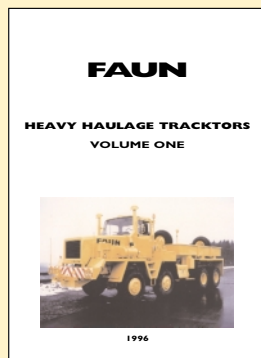

A range of simple books concerning heavy duty vehicles, size A4,  
each containing  $\pm$  10 to 12 drawings 1:50 or 1:87 scale

- 01 Faun Heavy Haulage Tractors (8x4, 8x8)
- 02 Faun Heavy Haulage Tractors (6x4, 6x6)
- 03 Kaeble Heavy Haulage Tractors
- 04 Berliet Desert & Oilfield Vehicles
- 05 Faun Desert & Oilfield Vehicles
- 06 MOL Desert & Oilfield Vehicles
- 07 F.T.F Heavy Haulage Tractors 1967 - 1994

### Forthcoming titles

- 08 MOL Heavy Haulage Tractors
- 09 Scammel Heavy Haulage Tractors
- 10 TITAN Heavy Haulage Tractors

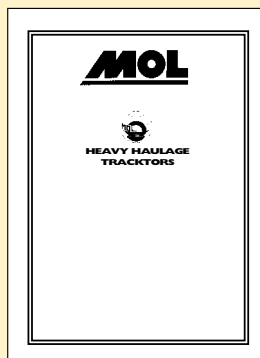
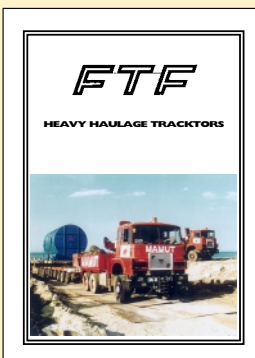
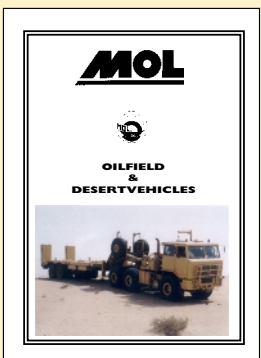
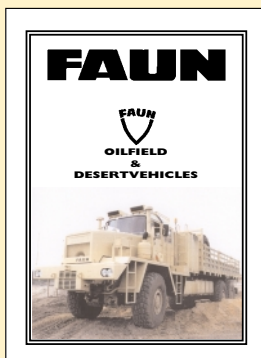
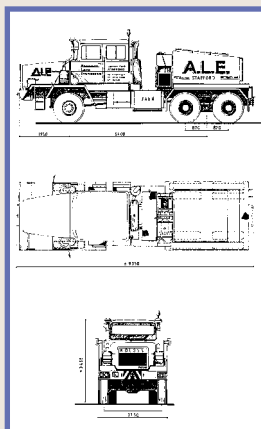

All scaledrawings are handmade by:

© copyright protected

J.F. van der Touw  
Prinses Beatrixlaan 22  
NL 2273 XN Voorburg  
Netherlands

Phone: 0031 70 386 8083  
Fax: 0031 70 399 6416

info: theo.gijsbers@home.nl

# Serie A

# Heavy Haulage

Drawing size	A2	A3	A3	A4
Drawing scale	1:50	1:50	1:87	1:87

Serial Nr	Manufacturer	Type	Used by	Traktion				year
A-001	M.A.N.	42.502 VFS		8x4		×		1991
A-002	Faun	L 1212/377 S	Toense	8x6		×	×	1965
A-003	Kaelble	KDV 24 Z 430 W		6x6		×	×	1975
A-004	Mercedes-Benz	3548 S	Mammoet Belgie	8x4		×	×	1991
A-005	M.A.N.	48.700 VFAS	Fraser	8x8		×	×	1989
A-006	Berliet	TE		6x6		×	×	1965
A-007	Atkinson	T-6066 C		6x4		×	×	1970
A-008	Willeme	VV-200		8x4		×	×	1949
A-009	Titan	Z 32.42		6x6		×	×	1979
A-010	Pacific	P-16 Ultra	SAR/SAS	6x4		×	×	1979
A-011	F.T.F.	F 8.29 D	Stoof	6x4		×	×	1974
A-012	Mol	T-6066 Giant	Capelle	6x6		×	×	
A-013	Kaelble	Z 6 R 3A	D.R.B.	6x6		×	×	1937
A-014	F.T.F.	F 8.28 D	Mammoet	6x4		×	×	1978
A-015	Faun	FZ 40.45/46		6x6				
A-016	F.T.F.	F 10.30 Mammut	Colombia	6x6		×	×	1978
A-017	Berliet	TBO 15		6x4		×	×	1972
A-018	Pacific	M 26 A1	E.D.F.	6x6		×	×	1952
A-019	Faun	L 1212/45 ZA		6x6		×	×	
A-020	Mol	6x4	Sarens	6x4		×	×	
A-021	Titan	Z 40.42 S	Zwagerman	8x4		×	×	1979
A-022	Kaelble	KDV 24 Z		6x6	1975	×	×	
A-023	Kaelble	KDV 12 Z 6	D.B.P.	6x6		×	×	1963
A-024	Mercedes-Benz	3553		8x4				
A-025	Camb	BF 300 /Tam		8x2		×	×	
A-026	F.T.F.	F 7.25 D	Stoof	6x4		×	×	1967
A-027								
A-028	Scammell	Constructor		6x6		×	×	1962
A-029	Faun	F 60/12/40	Toense	4x4		×	×	1967
A-030	Kaelble	KDVW 421 Z	DB	6x6		×	×	1962
A-031	Faun	HZ 70.80/50 W		8x8		×	×	1982
A-032	Faun	HZ 50.60/50 W		8x8		×	×	1979
A-033	Faun	FZ 42.75/42		8x6		×	×	

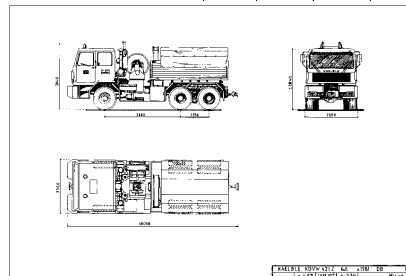
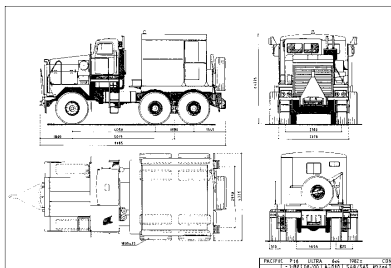

All scaledrawings are handmade by:

J.F. van der Touw  
Prinses Beatrixlaan 22  
NL 2273 XN Voorburg  
Netherlands

Phone: 0031 70 386 8083  
Fax: 0031 70 399 6416

© copyright protected

info: theogijsbers@home.nl

# Serie A

# Heavy Haulage

Drawing size	A2	A3	A3	A4
Drawing scale	1:50	1:50	1:87	1:87

Serial Nr	Manufacturer	Type	Used by	Tracktion				year
A-034								
A-035	Faun	L 1212/375 VS	Toense	8x8		X		X 1970
A-036	Faun	HZ 46.40/49		8x8		X		X
A-037	Faun	Goliath	G.E.C.	8x8		X		X 1989
A-038	Faun	Gigant		8x8		X		X 1987
A-039	Titan	Z 40.530 F	Ovit	6x6				1989
A-040	Titan	Z 60.525 H		8x8		X		X 1985
A-041	Willeme	TG 200	Stag	8x4		X		X 1974
A-042	Willeme	TG 200	Scalex	8x4		X		X 1975
A-043	Faun	HZ 50.45/50	ZTE	8x8		X		X 1986
A-044	Scammell	Contractor Mk.2		6x4		X		X 1976
A-045	Kaelble	KDV 24 Z 450 W		6x6		X		X 1981
A-046	Kaelble	KDV 400 Z		6x6		X		X 1967
A-047								
A-048	Mercedes-Benz	3850 A	Lastra	6x6		X		X 1983
A-049	Kaelble	K 632 Z & K 633 Z		4x4				
A-050	Faun	L 1212 ZA	Bauman	6x6		X		X 1969
A-051	Faun	FZ 40.45/45		6x6		X		X 1985
A-052	Faun	HZ 40.45/45 W	Grundt	6x6		X		X 1987
A-053	Tatra	T 813		6x6		X		X 1973
A-054	Faun	L 7 R		4x2		X		X 1948
A-055	Mack	B 80 SX	Bauman	6x4		X		X 1958
A-056	Tractomas	TRB 66 OZ		6x6		X		X 1987
A-057	Titan	Z 46.42 S	Nygaard	10x8		X		X 1981
A-058	M.A.N.	40.400 DFA		6x6		X		X 1980
A-059	M.A.N.	48.525 VFAS		8x8		X		X 1982
A-060	Magirus-Deutz	360 D 34 AS		6x6				1977
A-061	Tatra	T 815		6x6				1985
A-062	Faun	HZ 36.40/45		6x6		X		X 1979
A-063	Daf/Ginaf	FDT 95.400	vd Vlist	8x4		X		X
A-064	Terberg	F 1850 T		8x4		X		X 1981
A-065	Terberg	F 1850	van Seumeren	8x4		X		X 1991
A-066	Terberg	F 2950	van Seumeren	10x6		X		X 1992
A-067	Scammell	Junior Constructor		6x4		X		X
A-068	Faun	FZ 40.45/45W		6x6		X		X 1987
A-069	Faun	Koloss	A.L.E.	6x6		X		X 1989
A-070	F.T.F.	F 8.26 D	Big Lift	6x4		X		X 1976
A-071	F.T.F.	MS 40.50		6x4		X		X 1973
A-072	Foden	FGHT 8/80		6x4		X		X 1957
A-073	Unipower	C	Econofreight	6x4		X		X 1996
A-074	Mercedes-Benz	3336 S 38		8x4		X		X 1985
A-075	Faun	L 1206/45 WZv	Seumeren	6x6		X		X

All scaledrawings are handmade by:

J.F. van der Touw  
Prinses Beatrixlaan 22  
NL 2273 XN Voorburg  
Netherlands

Phone: 0031 70 386 8083  
Fax: 0031 70 399 6416

© copyright protected

info: theogijsbers@home.nl

# Serie A

# Heavy Haulage

Drawing size	A2	A3	A3	A4
Drawing scale	1:50	1:50	1:87	1:87

Serial Nr	Manufacturer	Type	Used by	Tracktion				year
A-076	F.T.F.	FS 10.30 DSS		8x4			×	1980
A-077	Kaelble	Z 4 GR	D.R.B.	4x2			×	1936
A-078	Scammell	Amazon	Wynns	6x4			×	1978
A-079	Kaelble	Z 6 R 2A 100		6x4			×	1937
A-080	Kaelble	Z 6R		6x4			×	1934
A-081	Titan	Z 42.615 F	Krause	8x6			×	1984
A-082	Mol	TG 300		8x8			×	1991
A-083								
A-084	Kaelble	KDV 631 SF		6x6			×	1954
A-085	Faun	HZ 36.45/45 WP		6x6			×	1973
A-086	Faun	HZ 34.30/41		6x6			×	1977
A-087	Kaelble	KDV 32 Z 8T		6x6			×	1962
A-088	Scammell	Contractor	Sparrows	6x4			×	
A-089	Mol	TG 250		8x8			×	1996
A-090	Kaelble	KDV 22 Z 8		6x6			×	1962
A-091	Kaelble	K 4VW 615 Z		8x8			×	1985
A-092	Oshkosh	64-H-1670		6x4				
A-093	Scammell	Super Constructor		6x6			×	1965
A-094	Oshkosh	M-911		8x6				1981
A-095	Atkinson	BT 1366 CA		6x4			×	1963
A-096	Pacific	8x8		8x8			×	
A-097	Henschel	100 PS	Reichsbahn	6x4			×	1935
A-098	F.T.F.	FS 8.8.20 D	vd Meijden	8x4			×	
A-099	Faun	HZ 46.40/49	S.T.L.	8x8			×	
A-100	Drive	8x8	Translast/Sainert	8x8			×	
A-101	F.T.F.	FD 8.20 D	E.C.T.	6x4			×	1994
A-102	F.T.F.	FS 8.8.20 D	v. Wezel	8x4			×	1982
A-103	F.T.F.	FS/FD 8.26 D		6x4			×	1989
A-104	Trabosa	TBA-1	Sainert	8x8			×	
A-105	Rotinoff	Atlantic		6x4			×	1968
A-106	Berliet	T-12/2		8x8			×	1962
A-107	Hendrickson	"Hulk" 360"		6x6				

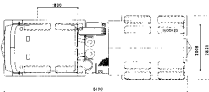
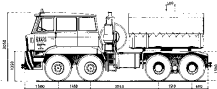

VALLEN 10:00-841 STAG F  
1:187 (80:50) A-051 JST

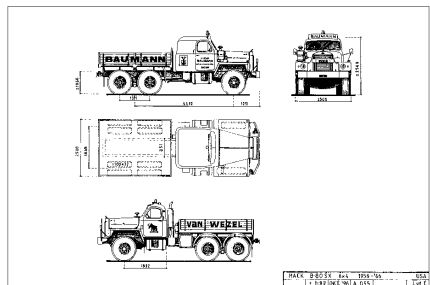

VALLEN 10:00-841 STAG F  
1:187 (80:50) A-051 JST

All scaledrawings are handmade by:

© copyright protected

J.F. van der Touw  
Prinses Beatrixlaan 22  
NL 2273 XN Voorburg  
Netherlands

Phone: 0031 70 386 8083

Fax: 0031 70 399 6416

info: theogijsbers@home.nl

# Serie B Trailers

Drawing size	A2	A3	A3	A4
Drawing scale	1:50	1:50	1:87	1:87

Serial Nr	Manufacturer	Type	Used by				
B-001	Crane	230 tons girder trailer	Pickford	×		×	
B-002	Kassbohrer	STH 18 + STH 35		×		×	
B-003	Crane	250 tons girder trailer	Wynns	×		×	
B-004	Cometto	GR-5 40 tons			×		×
B-005	Talbert	T 3 D 75 RG			×		×
B-006	Broshuis	3.DOV-39			×		×
B-007	SEAG	LR 40.4 Strassenroller			×		×
B-008	Nooteboom	ODU-33-W			×		×
B-009	Crane	45 / 85 tons					1973
B-010	Nicolas	R4 - R6					1966
B-011	Scheuerle	K-100					
B-012							
B-013	Crane	90 tons girder trailer					
B-014	Cometto	41 M platform			×		×
B-015	Culemeyer	Strassenroller					1934
B-016	Scheuerle	K-175			×		×
B-017	Nooteboom	OSDB 45W + OSDAZ 45			×		×
B-018	K.F.M.	TSA 84-157		×		×	
B-019	Crane	200 tons girder trailer	Pickfords	×		×	
B-020	Scheuerle	Euro combi 2 bed 4			×		×
B-021	Crane	200 tons platform	Sunters		×		×
B-022	Trabosa	100 tons desert trailer					
B-023	Goldhofer	TUP-5			×		×
B-024	Scheuerle	T-150-81L-L		×		×	ca. 1970
B-025	Mol	DT 89/55 WAL			×		×
B-026	Titan	SHHT 3 oilfield					
B-027	Goldhofer	SPOE 2 oilfield			×		×
B-028							
B-029	Mol	1112/40 WAL oilfield			×		×
B-030	Scheuerle	Ketelbrug Krause		×		×	1981

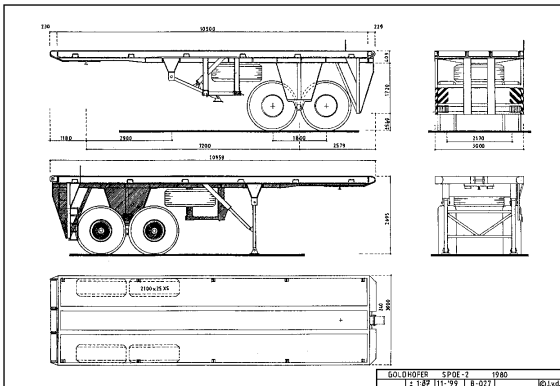

All scaledrawings are handmade by:

© copyright protected

**J.F. van der Touw**  
 Prinses Beatrixlaan 22  
 NL 2273 XN Voorburg  
 Netherlands

Phone: 0031 70 386 8083

Fax: 0031 70 399 6416

info: [theo.gijsbers@home.nl](mailto:theo.gijsbers@home.nl)

# Serie D

## Dumptrucks

Drawing size	A2	A3	A3	A4
Drawing scale	1:50	1:50	1:87	1:87

Serial Nr	Manufacturer	Type	Tracktion				year
D-001	Mack	LRVSW	6x4		×		1957
D-002	Foden	FED - 6	6x4		×	×	1961
D-003	Faun	K- 20/41	4x2		×	×	1960
D-004	Faun	K - 10/28 AP	4x4		×	×	1963
D-005	Mack	MP 404X Mackpack	4x4		×	×	1975
D-006	Euclid	R-45 Senes	6x4		×	×	1962
D-007	Berliet	T-25	4x2		×	×	1963
D-008	Krupp	MK 17	4x2		×	×	1963
D-009	Aveling- Barford	SN	4x2		×	×	1959
D-010	Douglas	Automaster 22	6x4				1960
D-011	Perlini	Type 381	4x2				1975
D-012	Willème	TE - 25	4x2		×	×	1962
D-013	Euclid	R-30 Series	4x2		×	×	1965
D-014							
D-015	Scammell	Sherpa Mk.1 & Mk.2	4x2		×	×	1973
D-016	Astra	BM 22	4x2		×	×	1973
D-017	Aveling - Barford	SL - 300	4x2				1965
D-018	C.V.S.	Dm - 210	4x4				1983
D-019	G.H.H.	MK - V 40	4x2				1985
D-020							
D-21	Kockums	442-B	4x2				1978
D-022	Komatsu	15 Ton	4x2		×	×	1964
D-023	Terberg	TS - 25	4x2				1985
D-024	Krupp	AMK - 23	4x4		×	×	1965
D-025	Kaelble	KVV-20 N	4x4		×	×	1979
D-026	Kiruna	K 250/28	4x2				1978
D-027	E & N	666-B	6x4				1979
D-028	Werklust	WD - 3	6x6		×	×	1980
D-029	Kaelble	KDV 32 E 8 T	6x6				1962
D-030	Mack	LVX	4x2		×	×	1957
D-031	A.E.C.	HDK 4 LA	4x2		×	×	1960
D-032	Faun	K 15/37 V	4x2		×	×	1959
D-033	Terberg	FL-5000	6x6				1997
D-034	Euclid	B - 7 FD	4x2		×	×	1963
D-035	Terex	33 - 19	6x4	×		×	1974
D-038	Faun	K 20/38 VA	4x4		×	×	1963
D-037	Willème	TE- 215	4x2		×	×	
D-038	Mack	M 45 SX	6x4				
D-039	Isco	IC - 245 R	6x4				1975
D-040	Titan	Type 2200	4x2				
D-041	Mack	M 30 SX	4x2		×	×	
D-042	Unit Rig	MT - 4400	4x2				1995
D-043	Berliet	T-100	6x4				1959

All scaledrawings are handmade by:

J.F. van der Touw  
Prinses Beatrixlaan 22  
NL 2273 XN Voorburg  
Netherlands

Phone: 0031 70 386 8083  
Fax: 0031 70 399 6416

© copyright protected

info: theo.gijsbers@home.nl

# Serie M

## Eightwheelers

Drawing size	A2	A3	A3	A4
Drawing scale	1:50	1:50	1:87	1:87

Serial Nr	Manufacturer	Type	Tracktion			year
M-001	Ginaf	Type 480	8x8		×	1980
M-002	Mack	DMM 685 EX	8x4		×	1979
M-003	Pegaso	1056/52 L	8x2		×	1970
M-004	Faun	L 1500 D 587	8x4		×	1938
M-005	E.R.F.	68 GX	8x4		×	1956
M-006	Terberg	F-1800	8x8		×	1978
M-007	Mowag	28 ton	8x4		×	1975
M-008	Mack	DM 685 S	8X6		×	1976
M-009	DAF	FAK 95 WS	8x2		×	1991
M-010	Hino	FY	8x4			1991
M-011	F.T.F.	F 8.30 DS	8x4			
M-012	Kenworth	K-150	8x4			1980
M-013	Mol	T -4584	8x4			1996
M-014	Foden	RG 20/30	8x4			1979
M-015	Leyland	Octopus	8x4		×	1962
M-016	F.T.F.	F 8.8.20 D	8x4		×	
M-017	DAF	AST 2400 DK	8x4		×	1973
M-018	Barreiros	82/35	8x2		×	1974
M-019	DAF	FAD 27 HS	8x4		×	
M-020	A.E.C.	Mammoth Mayor Mk.5	8x4		×	1964
M-021	Scammell	Routemaster Mk.2/3	8x4		×	
M-022	Saurer	D 330 B	8x4			
M-023	Seddon	24-8-LX	8x4			1962
M-024	Tatra	Type 813	8x8		×	
M-025	Ginaf	F 520	10x8		×	1984

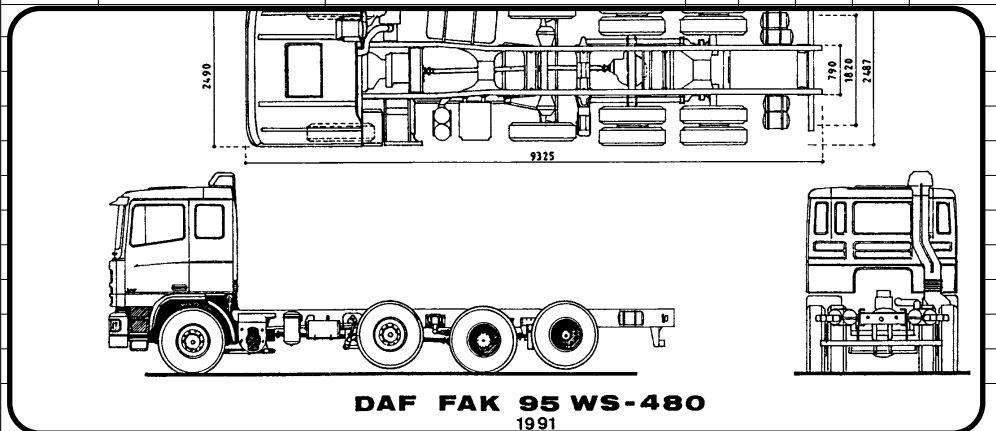

All scaledrawings are handmade by:

J.F. van der Touw  
Prinses Beatrixlaan 22  
NL 2273 XN Voorburg  
Netherlands

Phone: 0031 70 386 8083  
Fax: 0031 70 399 6416

© copyright protected

info: theo.gijsbers@home.nl



# Serie S

## Sixwheelers of the 50<sup>S</sup> & the 60<sup>S</sup>

Drawing size	A2	A3	A3	A4
Drawing scale	1:50	1:50	1:87	1:87

Serial Nr	Manufacturer	Type	Used by	Tracttion				year	
S-001	Faun	L 900 D 567		6x4		X		X	nc
S-002	Henschel	36 W 3		6x4		X		X	nc
S-003	Krupp	L 8 N 63		6x4		X		X	fc
S-004	Bernard	DI 6.58		6x2					nc
S-005	Bernard	CA 6 LW	Becquet	6x2					nc

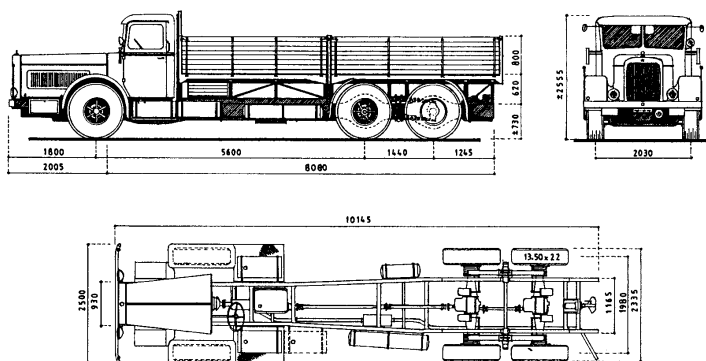

**HENSCHEL 36 W 3**

1937

All scaledrawings are handmade by:

© copyright protected

J.F. van der Touw  
Prinses Beatrixlaan 22  
NL 2273 XN Voorburg  
Netherlands

Phone: 0031 70 386 8083

Fax: 0031 70 399 6416

info: [theo.gijsbers@home.nl](mailto:theo.gijsbers@home.nl)

# Serie T

## trucks of the 50<sup>S</sup> & the 60<sup>S</sup>

Drawing size	A2	A3	A3	A4
Drawing scale	1:50	1:50	1:87	1:87

Serial Nr	Manufacturer	Type	Tracktion	Forward/Normal Control				
T-001	Krupp	Titan / Super Titan	4x2		X		X	nc
T-002	Faun	L-8	4x2		X		X	nc
T-003	Mercedes-Benz	LP/LPS 333	6x2		X		X	fc
T-004	Leyland	Super Hippo	6x4		X		X	nc
T-005	Mercedes-Benz	L 329	4x2		X		X	nc
T-006	Kromhout	V 6 D / DVB	4x2/6x2		X		X	nc/fc
T-007	Berliet	GBO/TBO HC	6x4					nc
T-008	Volvo	L 395	4x2/6x2					nc
T-009	Scania-Vabis	L/LS 7	4x2/6x2		X		X	nc
T-010	Willeme	R-15	6x2					nc
T-011	Berliet	GPM 10 W	6x2		X		X	nc
T-012	Mack	B 8136 SX	6x6		X		X	nc
T-013	Kromhout	V-5	4x2		X		X	nc
T-014	Willeme	RD-615	6x2					nc
T-015	Mack	NR	6x4		X		X	nc
T-015a	Mack	NR	6x4		X		X	nc
T-016	Mercedes-Benz	L 315 S	6x2		X		X	nc
T-017	Mack	N 61	4x2/6x4					fc
T-018	Mack	LJSWX	6x4		X		X	nc
T-019	Diamond T	Type 920	6x4					nc
T-020	A.E.C.	Mammoth	4x2/6x4					nc
T-021	Bussing	8000 S	4x2		X		X	nc
T-022	Mack	B-60	6x4		X		X	nc
T-023	Kaelble	K 631 L / LF	4x2		X		X	nc/fc
T-024	Mack	F 607	4x2/6x4		X		X	fc
T-025	Fiat	690 NI / TI	6x2		X		X	fc
T-026	Mercedes-Benz	LG 6600	4x4		X		X	nc
T-027	Mercedes-Benz	L 6600	4x2		X		X	nc
T-028	Leyland	Beaver	4x2		X		X	nc

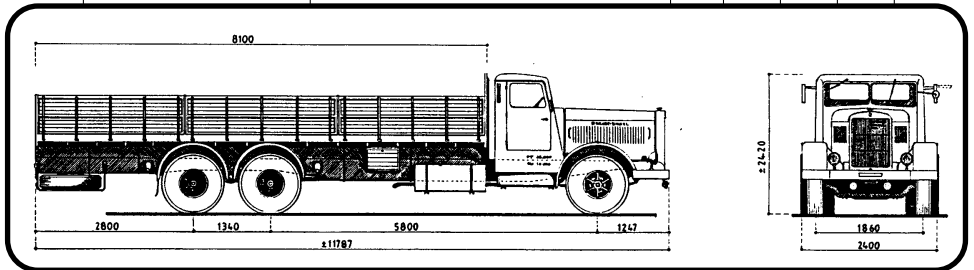

All scaledrawings are handmade by:

J.F. van der Touw  
Prinses Beatrixlaan 22  
NL 2273 XN Voorburg  
Netherlands

Phone: 0031 70 386 8083  
Fax: 0031 70 399 6416

© copyright protected

info: theogijsbers@home.nl

# Serie W

## Desert & Oilfield

Drawing size	A2	A3	A3	A4
Drawing scale	1:50	1:50	1:87	1:87

Serial Nr	Manufacturer	Type	Tracktion				year
W-001	Willeme	W 8 SAT	6x6		X		1962
W-001a	Willeme	W 6 SA	6x6		X	X	1962
W-002	Kenworth	KW 953	6x6		X	X	1971
W-003	Faun	LK 912 P/46 A	6x6		X	X	1962
W-004	Berliet	GBO 15 P	6x6		X	X	1962
W-005	Atkinson	Omega	6x6		X	X	1962
W-006	RGléTourneau	Transporter	6x6		X	X	1970
W-007	Scammell	Constructor	6x6		X	X	1958
W-008	Pacific	P 12 W Roughneck	6x6		X	X	1985
W-009	Berliet	T-100 Tulsa	6x6		X	X	1959
W-010	Thornycroft	Big Ben Sandmaster	6x6				1965
W-011	Oshkosh	J-3080	6x6		X	X	1980
W-012	Mol	T-6066/5	6x6		X	X	1983
W-013	Foremost	Delta 3	6x6		X	X	1986
W-014	Faun	HZ 50.25/73	10x8		X	X	1984
W-015	Scammell	Super Constructor tractor	6x6		X	X	1972
W-016	Berliet	GXO	6x6		X	X	1972
W-017	KFM	TB-600 Desert Lion	6x6		X	X	1983
W-018	CDN Flextrac	Norcan 300	6x6		X	X	1975
W-019	Titan	Z 50.615 H	6x6		X	X	1984
W-020a	Faun	HL 40.45/83	6x6		X	X	1985
W-020b	Faun	HL 40.45/83	6x6		X	X	1985
W-021	Mercedes-NAW	4050 A/65	8x8		X	X	1979

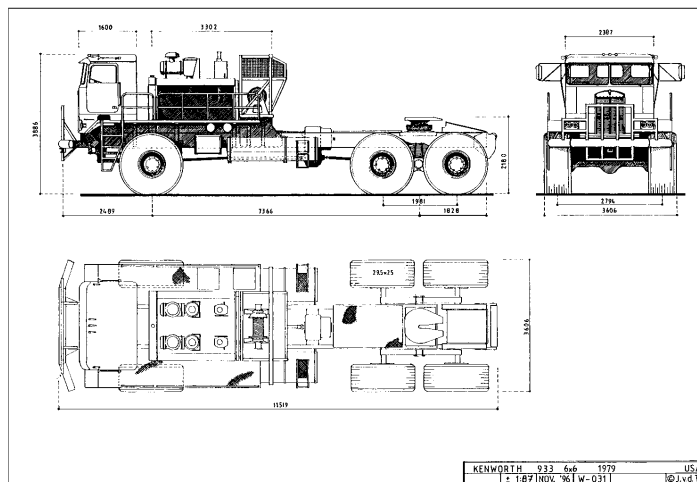

All scaledrawings are handmade by:

© copyright protected

**J.F. van der Touw**  
 Prinses Beatrixlaan 22  
 NL 2273 XN Voorburg  
 Netherlands

Phone: 0031 70 386 8083  
 Fax: 0031 70 399 6416

info: theogijsbers@home.nl

Serial Nr	Manufacturer	Type	Used by	Tracktion				year	
W-022	Oshkosh	J-2065		6x6			X	X	1981
W-023	Foremost	Magnum 4		8x8			X	X	1979
W-024	Mol	T-5266/05 F		6x6			X	X	1982
W-025	Irtex	PE		8x8			X	X	1982
W-026	Nicolas	TOF 21.02		6x6			X	X	1985
W-027	Scammell	S-24		6x6					1983
W-028	Berliet	GPO 71 P		6x6			X	X	1968
W-029	Mol	HF 3866		6x6			X	X	
W-030	Mercedes-NAW	4050 AS		8x8			X	X	
W-031	Kenworth	KW 993		6x6			X	X	1979
W-032	Faun	HZ 40.45/45 W		6x6			X	X	1982
W-033	Faun	F 687/41 SAN		4x4			X	X	1960
W-034	Faun	HZ 40.45/45	ussr	6x6			X	X	1982
W-035	Titan	Z 50.320 H/75		6x6			X	X	1986
W-036	Kromhout	V 6 D & T 6 D		6x6			X	X	1954
W-037	Mol	HF 5066/05		6x6			X	X	1986
W-038	Titan	Z 40.52 S/38		6x6			X	X	1983
W-039	Mol	F-7066		6x6			X	X	1996
W-040	Willeme	W 6 SA		6x6			X	X	1962
W-041	A.E.C.	Roadtrain		8x8	X		X		1934
W-042	Mol	HF 4066		6x6			X	X	1986
W-043	Oshkosh	66-D-1840		6x6			X	X	
W-044	Faun	HL 30.35/52		6x6			X	X	1983
W-045	Mack	B-80 SX	nam	6x4			X	X	
W-046	Faun	HZ 40.45/45		6x6			X	X	
W-047	Berliet	T-100 nr.1	def.version	6x6	X		X		
W-048	Berliet	T-100 nr.1	prototype	6x6	X		X		1956
W-049	Berliet	T-100 nr.2		6x6	X		X		
W-050	Berliet	GBC 8 M	Gazelle	6x6			X	X	
W-051	Faun	HS 40.45/45		6x6			X	X	
W-052	Pacific	P 12 W Super	Roughneck	6x6			X	X	
W-053	Berliet	TBO 15		6x4			X	X	
W-054	Berliet	TBO 15 M3		6x4			X	X	
W-055	International	COF 5470		6x6			X	X	1978
W-056	Oshkosh	J-30120	tractor	6x6			X	X	1982
W-057	Kenworth	KW 953 Super		6x6			X	X	
W-058	Willeme	W 8 SAR		6X6					1975

All scaledrawings are handmade by:

J.F. van der Touw  
Prinses Beatrixlaan 22  
NL 2273 XN Voorburg  
Netherlands

Phone: 0031 70 386 8083  
Fax: 0031 70 399 6416

© copyright protected

info: theo.gijsbers@home.nl

# Serie W

## Desert & Oilfield

Drawing size	A2	A3	A3	A4
Drawing scale	1:50	1:50	1:87	1:87

Serial Nr	Manufacturer	Type	Used by	Tracktion			year
W-059	Kenworth	KW 552		6x6		×	1965
W-060	Magirus-Deutz	Uranus 250 AE		6X6		×	1958
W-061	Faun	L 1400		8x4		×	1958
W-062	Mol	HF 7066		6x6		×	2000
W-063	Thornycroft	Antar	IPC	6x4		×	1950
W-064	Mol	TB 800		6x6		×	
W-065	Mol	F 6566		6x6		×	1983
W-066	Mol	HF 6066		6x6		×	1999
W-067	Mol	BK 1244 & BKF 12444x4				×	
W-068	Scammell	Super Constructor		6x6		×	1967
W-069	Titan	Z 50.525 H		6x6		×	1983
W-070a	Oshkosh } set	J-series	China	6x6		×	
W-070b		J-series	China	6x6		×	
W-071	Kenworth	KW 953 S	c.o.e.	6x6		×	
W-072	Kenworth	KW 548		6x4		×	1969
W-073	Canadair Flextrack	CF60 + CF 300				×	1974
W-074	Terberg	SF 1300 S		6x6		×	1978

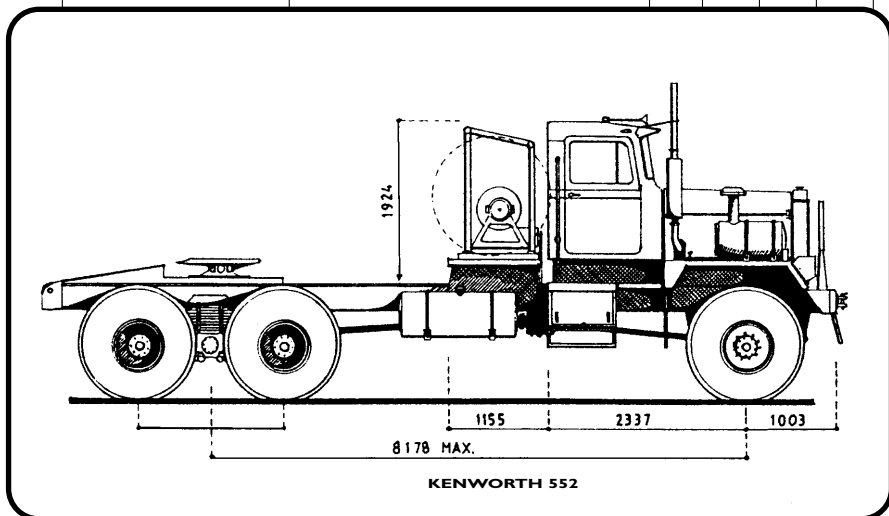

All scaledrawings are handmade by:

J.F. van der Touw  
Prinses Beatrixlaan 22  
NL 2273 XN Voorburg  
Netherlands

Phone: 0031 70 386 8083  
Fax: 0031 70 399 6416

© copyright protected

info: theo.gijsbers@home.nl

# Serie Z

## Special Vehicles

Drawing size	A2	A3	A3	A4
Drawing scale	1:50	1:50	1:87	1:87

Serial Nr	Manufacturer	Type					year
Z-001	Euclid	24 TDT-128 W Coalhauler	×		×		1959
Z-002	Faun	L1412/51 VS 10x8 tractor			×		1969
Z-003	Kaeble	KVW 320 GZ 4x4 tractor			×		1980
Z-004	Faun	LK 208/49 A crane carrier			×		1959
Z-005	Faun	KF 120.83 16x8 A crane carrier			×		1975
Z-006	Terberg	TS-60 pipe carrier	×		×		
Z-007	Reynolds-Boughton	Taurus 6x6 crashtender					
Z-008	Faun	L 908 TRPW					1960
Z-009	Werklust	MW 21 10x10 pipe carrier					1977
Z-010	Scheuerle	MPK 300.14.9 carrier	×		×		1982
Z-011	KW Dart	4120 120 ton coalhauler	×		×		1984
Z-012	Faun	L 1412/45 V 8x8 Sides ct			×		×
Z-013	Faun	L 1412/52 V 8x8 chassis/cab			×		×

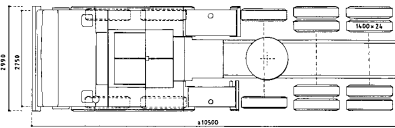
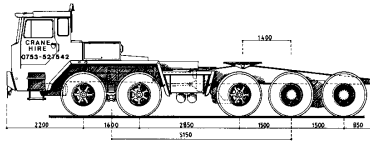

FAUN L 1412/51 VS 10x8 BALDWIN'S GB 1969  
I: 1:87 | 108-96 | Z: 002 | 0: 0.51444 | JE: v4: 700W

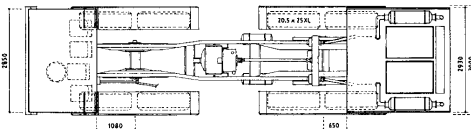
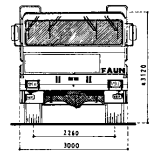
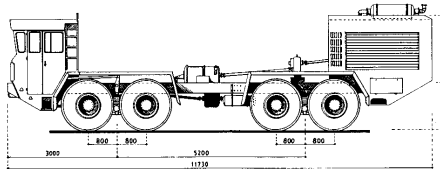

FAUN LF 1412 S2 V 8x8 1973  
I: 1:50 | 04-99 | F: 002 | 0: 0.4x63

All scaledrawings are handmade by:

© copyright protected

J.F. van der Touw  
Prinses Beatrixlaan 22  
NL 2273 XN Voorburg  
Netherlands

Phone: 0031 70 386 8083

Fax: 0031 70 399 6416

info: theogijsbers@home.nl



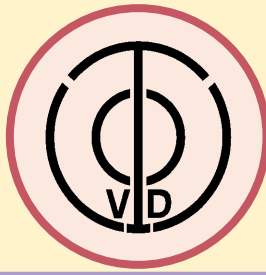

April 2001

All scaledrawings are handmade and © copyright protected by:

**J.F. van der Touw**  
**Prinses Beatrixlaan 22**  
**2273 XN Voorburg**  
**Netherlands**

Phone: 0031 70 386 8083

Fax: 0031 70 399 6416

This list will be updated every 6 month, or in a shorter period if neccasery  
You can receive the last list:

- Write, fax or phone to J.F. van der Touw, Prinses Beatrixlaan 22  
2273 XN Voorburg, the Netherlands  
Phone: 0031 70 386 8083  
Fax: 0031 70 399 6416
- Sending a email to [theo.gijsbers@home.nl](mailto:theo.gijsbers@home.nl) and ask for scaledrawinglist.  
You will receive the scaledrawinglist in Adobe Acrobat .pdf format.  
We have a small document ( $\pm$  300 kb) in black and white, and a bigger document ( $\pm$ 700kb) in full color. If you want to get on our mailinglist, please specifie the one you would like to receive

Scaledrawings in 1/50 are A<sup>2</sup> (420 x 594 mm) or at A<sup>3</sup> (297 x 420mm)

Scaledrawings in 1/87 are A<sup>3</sup> (297 x 420mm ) or at A<sup>4</sup> (210 x 297mm)

Prices:	A4:	fl. 3,-	€ 1,36	\$ 1,21
	A3:	fl. 5,-	€ 2,27	\$ 2,01
	A2:	fl. 7,50	€ 3,40	\$ 3,02

Booklets	fl. 20,00	€ 9,08	\$ 8,03
----------	-----------	--------	---------

Prices do not include shipping, and may vary due to changes in exchange rates

layout & design  
by Theo Gijsbers



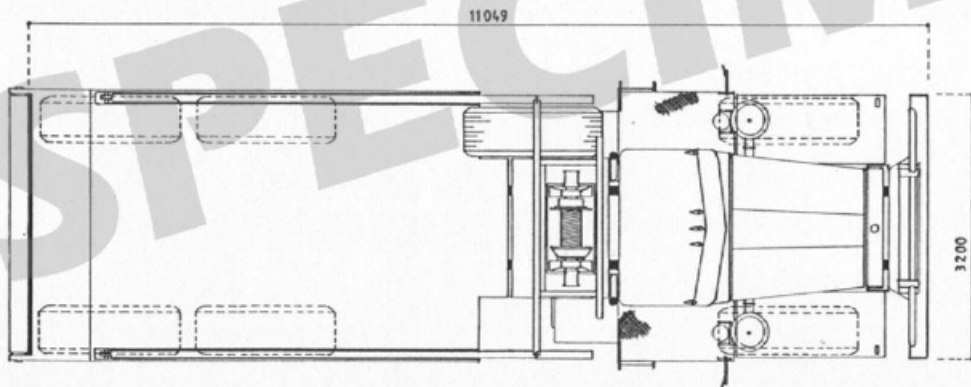
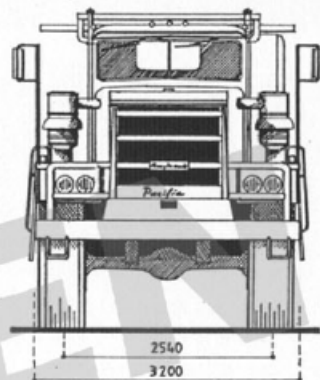
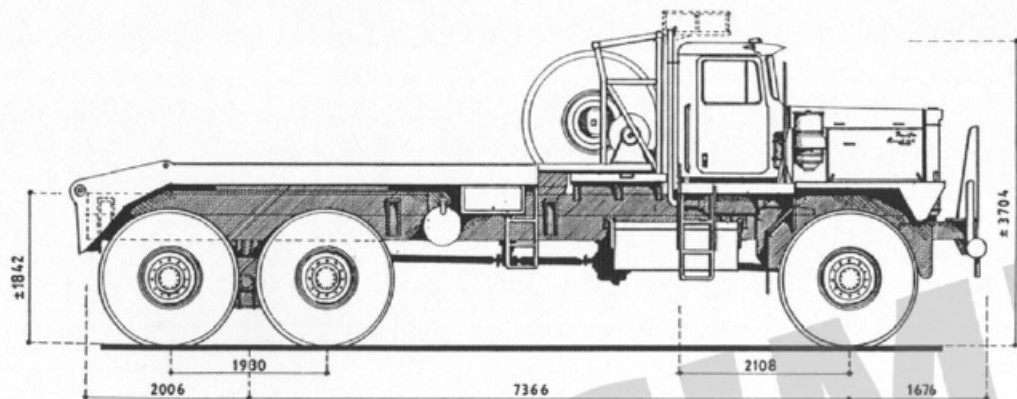

PACIFIC P-12-W 6x6 "ROUGHNECK" 1982	CDN
± 1:87 08-'96 W-008	J.F. v.d. TOUW